

Varenummer: 2031120M24200B1U

Beskrivelse: E+G Justerfod
GN 31-120-M24-200-B1-U

Note: U Uden møtrik, sekskant i toppen, spændeflade i bunden

Mål

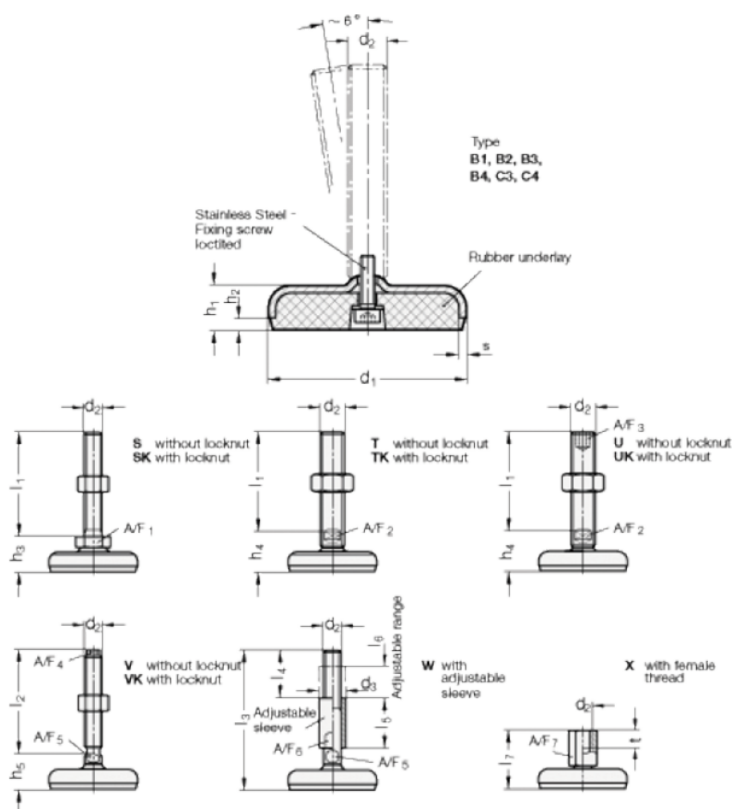

A/F2	= 19	s = 4
A/F3	= 12	
d1	= 120	
d2	= 24	
h1	= 22	
h2	= 6	
h4 +4.0/0	= 42	
l1	= 200	